



Data Structures and Algorithms

Jennifer Rexford

The material for this lecture is drawn, in part, from
The Practice of Programming (Kernighan & Pike) Chapter 2



Goals of this Lecture

- Help you learn (or refresh your memory) about:
 - Common data structures and algorithms
- Why? Shallow motivation:
 - Provide examples of pointer-related C code
- Why? Deeper motivation:
 - Common data structures and algorithms serve as “high level building blocks”
 - A power programmer:
 - Rarely creates programs from scratch
 - Often creates programs using building blocks



A Common Task

- **Maintain a table of key/value pairs**
 - Each key is a string; each value is an `int`
 - Unknown number of key-value pairs
- **Examples**
 - (student name, grade)
 - (“john smith”, 84), (“jane doe”, 93), (“bill clinton”, 81)
 - (baseball player, number)
 - (“Ruth”, 3), (“Gehrig”, 4), (“Mantle”, 7)
 - (variable name, value)
 - (“maxLength”, 2000), (“i”, 7), (“j”, -10)
- **For simplicity, allow duplicate keys** (client responsibility)
 - In Assignment #3, must check for duplicate keys!



Data Structures and Algorithms

- **Data structures**
 - **Linked list** of key/value pairs
 - **Hash table** of key/value pairs
- **Algorithms**
 - **Create**: Create the data structure
 - **Add**: Add a key/value pair
 - **Search**: Search for a key/value pair, by key
 - **Free**: Free the data structure



Data Structure #1: Linked List

- **Data structure:** Nodes; each contains key/value pair and pointer to next node

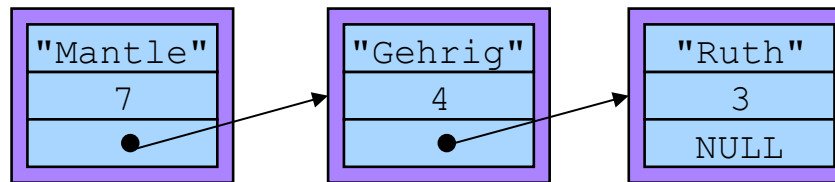

- **Algorithms:**
 - **Create:** Allocate Table structure to point to first node
 - **Add:** Insert new node at front of list
 - **Search:** Linear search through the list
 - **Free:** Free nodes while traversing; free Table structure



Linked List: Data Structure

```
struct Node {  
    const char *key;  
    int value;  
    struct Node *next;  
};  
  
struct Table {  
    struct Node *first;  
};
```

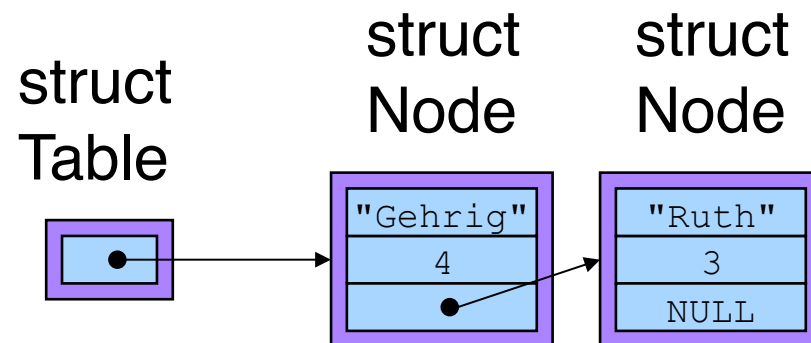



Linked List: Create (1)

```
struct Table *Table_create(void) {  
    struct Table *t;  
    t = (struct Table*)  
        malloc(sizeof(struct Table));  
    t->first = NULL;  
    return t;  
}
```

```
struct Table *t;  
...  
t = Table_create();  
...
```

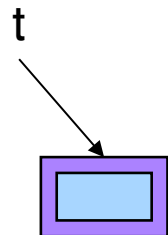



Linked List: Create (2)

```
struct Table *Table_create(void) {  
    struct Table *t;  
    t = (struct Table*)  
        malloc(sizeof(struct Table));  
    t->first = NULL;  
    return t;  
}
```

```
struct Table *t;  
...  
t = Table_create();  
...
```

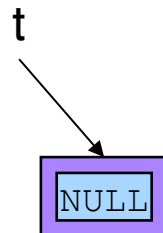



Linked List: Add (1)

```
void Table_add(struct Table *t,  
    const char *key, int value) {  
    struct Node *p = (struct Node*)malloc(sizeof(struct Node));  
    p->key = key;  
    p->value = value;  
    p->next = t->first;  
    t->first = p;  
}
```

```
struct Table *t;  
...  
Table_add(t, "Ruth", 3);  
Table_add(t, "Gehrig", 4);  
Table_add(t, "Mantle", 7);  
...
```

These are
pointers to
strings

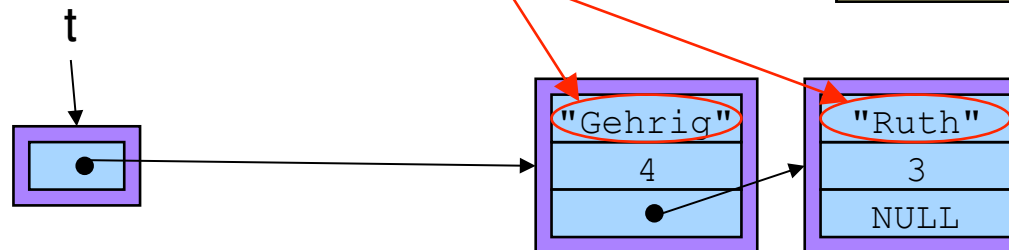



Linked List: Add (2)

```
void Table_add(struct Table *t,  
    const char *key, int value) {  
    struct Node *p = (struct Node*)malloc(sizeof(struct Node));  
    p->key = key;  
    p->value = value;  
    p->next = t->first;  
    t->first = p;  
}
```

```
struct Table *t;  
...  
Table_add(t, "Ruth", 3);  
Table_add(t, "Gehrig", 4);  
Table_add(t, "Mantle", 7);  
...
```

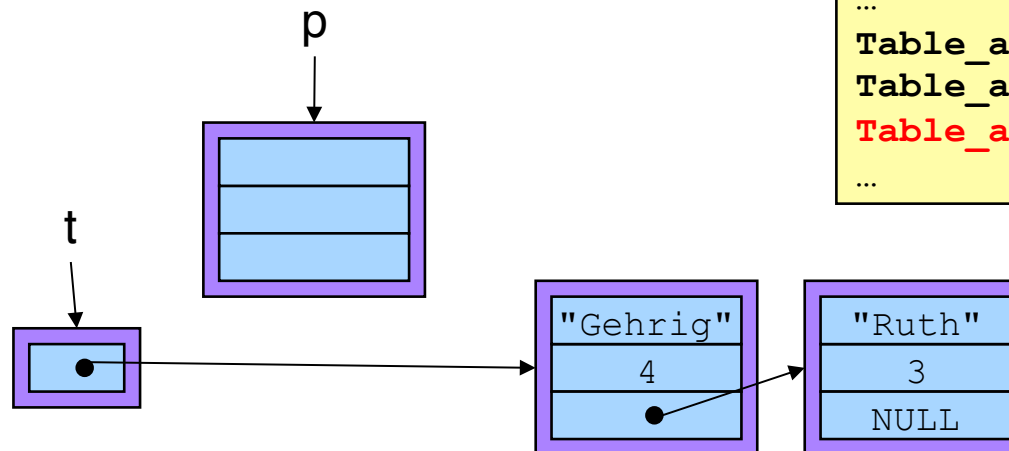



Linked List: Add (3)

```
void Table_add(struct Table *t,  
    const char *key, int value) {  
    struct Node *p = (struct Node*)malloc(sizeof(struct Node));  
    p->key = key;  
    p->value = value;  
    p->next = t->first;  
    t->first = p;  
}
```

```
struct Table *t;  
...  
Table_add(t, "Ruth", 3);  
Table_add(t, "Gehrig", 4);  
Table_add(t, "Mantle", 7);  
...
```

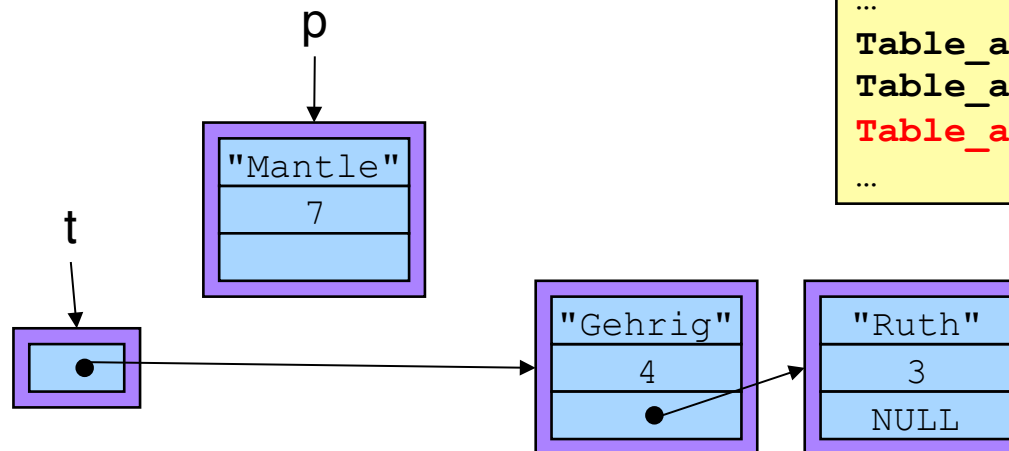



Linked List: Add (4)

```
void Table_add(struct Table *t,  
    const char *key, int value) {  
    struct Node *p = (struct Node*)malloc(sizeof(struct Node));  
    p->key = key;  
    p->value = value;  
    p->next = t->first;  
    t->first = p;  
}
```

```
struct Table *t;  
...  
Table_add(t, "Ruth", 3);  
Table_add(t, "Gehrig", 4);  
Table_add(t, "Mantle", 7);  
...
```

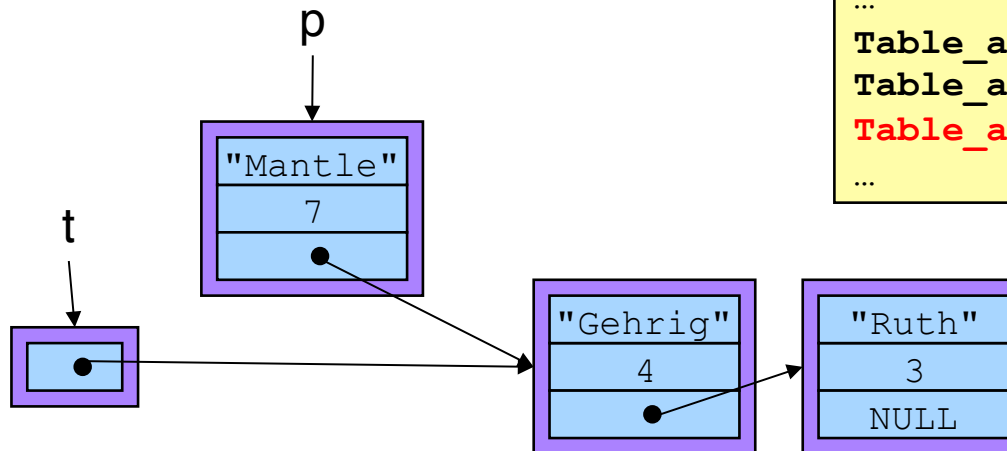



Linked List: Add (5)

```
void Table_add(struct Table *t,  
    const char *key, int value) {  
    struct Node *p = (struct Node*)malloc(sizeof(struct Node));  
    p->key = key;  
    p->value = value;  
    p->next = t->first;  
    t->first = p;  
}
```

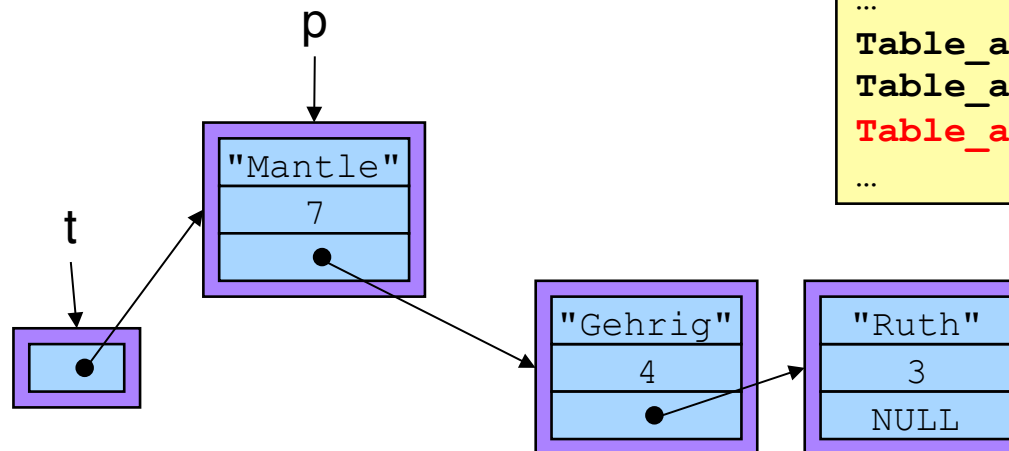

```
struct Table *t;  
...  
Table_add(t, "Ruth", 3);  
Table_add(t, "Gehrig", 4);  
Table_add(t, "Mantle", 7);  
...
```



Linked List: Search (1)

```
int Table_search(struct Table *t,  
    const char *key, int *value) {  
    struct Node *p;  
    for (p = t->first; p != NULL; p = p->next)  
        if (strcmp(p->key, key) == 0) {  
            *value = p->value;  
            return 1;  
        }  
    return 0;  
}
```

```
struct Table *t;  
int value;  
int found;  
...  
found =  
    Table_search(t, "Gehrig", &value);  
...
```

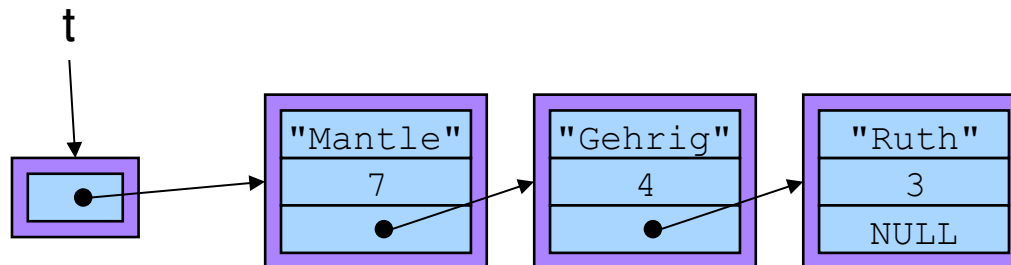



Linked List: Search (2)

```
int Table_search(struct Table *t,  
const char *key, int *value) {  
    struct Node *p;  
    for (p = t->first; p != NULL; p = p->next)  
        if (strcmp(p->key, key) == 0) {  
            *value = p->value;  
            return 1;  
        }  
    return 0;  
}
```

```
struct Table *t;  
int value;  
int found;  
...  
found =  
    Table_search(t, "Gehrig", &value);  
...
```

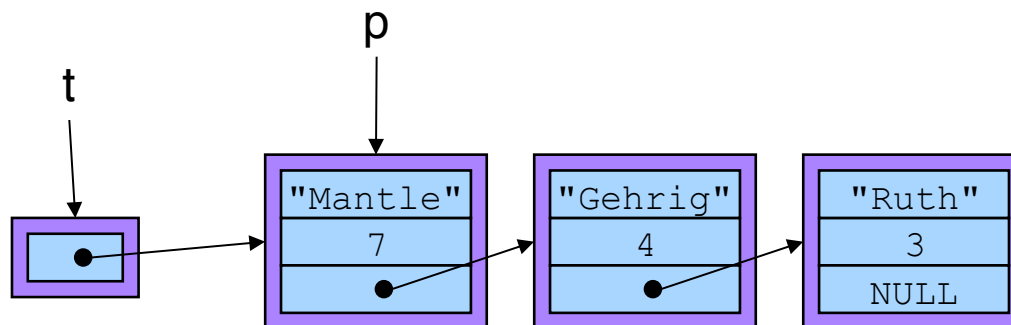



Linked List: Search (3)

```
int Table_search(struct Table *t,  
    const char *key, int *value) {  
    struct Node *p;  
    for (p = t->first; p != NULL; p = p->next)  
        if (strcmp(p->key, key) == 0) {  
            *value = p->value;  
            return 1;  
        }  
    return 0;  
}
```

```
struct Table *t;  
int value;  
int found;  
...  
found =  
    Table_search(t, "Gehrig" &value);  
...
```

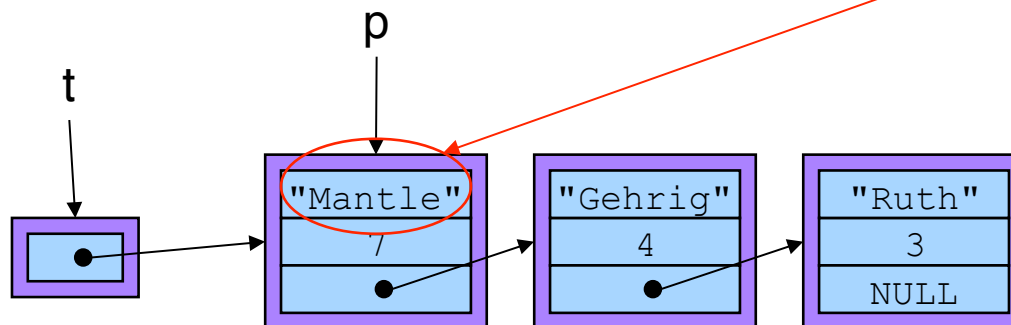



Linked List: Search (4)

```
int Table_search(struct Table *t,  
    const char *key, int *value) {  
    struct Node *p;  
    for (p = t->first; p != NULL; p = p->next)  
        if (strcmp(p->key, key) == 0) {  
            *value = p->value;  
            return 1;  
        }  
    return 0;  
}
```

```
struct Table *t;  
int value;  
int found;  
...  
found =  
    Table_search(t, "Gehrig", &value);  
...
```

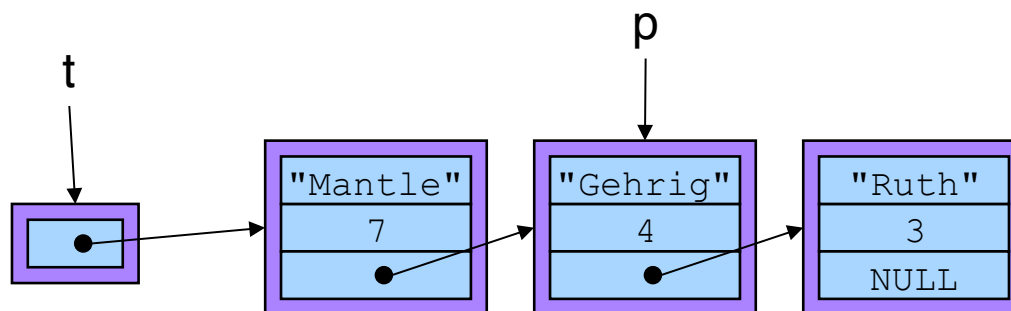



Linked List: Search (5)

```
int Table_search(struct Table *t,  
const char *key, int *value) {  
    struct Node *p;  
    for (p = t->first; p != NULL; p = p->next)  
        if (strcmp(p->key, key) == 0) {  
            *value = p->value;  
            return 1;  
        }  
    return 0;  
}
```

```
struct Table *t;  
int value;  
int found;  
...  
found =  
    Table_search(t, "Gehrig" &value);  
...
```

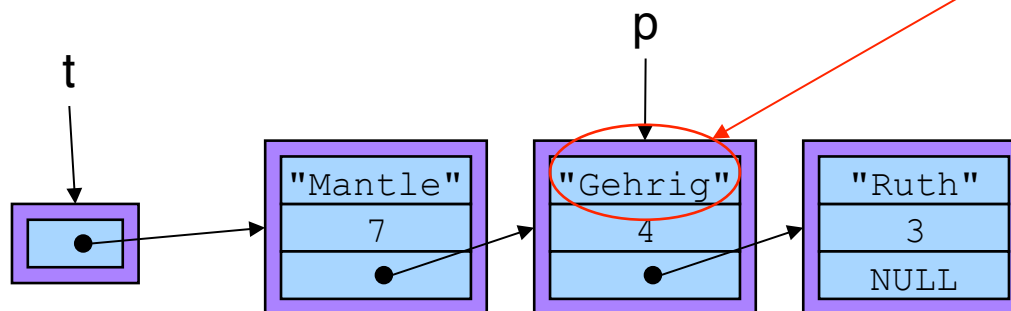



Linked List: Search (6)

```
int Table_search(struct Table *t,  
    const char *key, int *value) {  
    struct Node *p;  
    for (p = t->first; p != NULL; p = p->next)  
        if (strcmp(p->key, key) == 0) {  
            *value = p->value;  
            return 1;  
        }  
    return 0;  
}
```

```
struct Table *t;  
int value;  
int found;  
...  
found =  
    Table_search(t, "Gehrig", &value);  
...
```

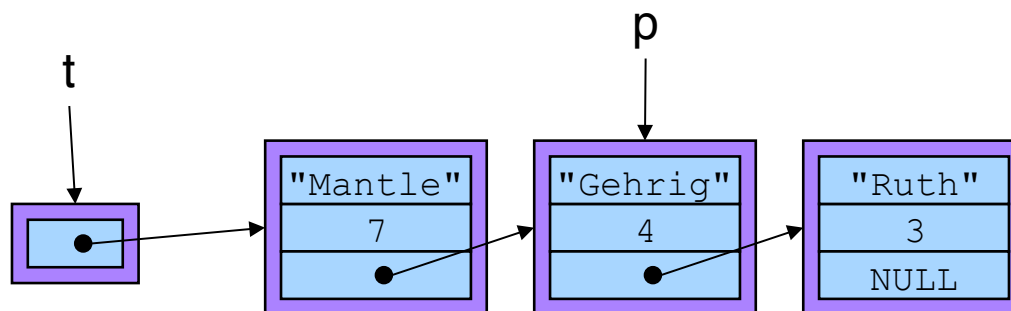



Linked List: Free (1)

```
void Table_free(struct Table *t) {  
    struct Node *p;  
    struct Node *nextp;  
    for (p = t->first; p != NULL; p = nextp) {  
        nextp = p->next;  
        free(p);  
    }  
    free(t);  
}
```

```
struct Table *t;  
...  
Table_free(t);  
...
```

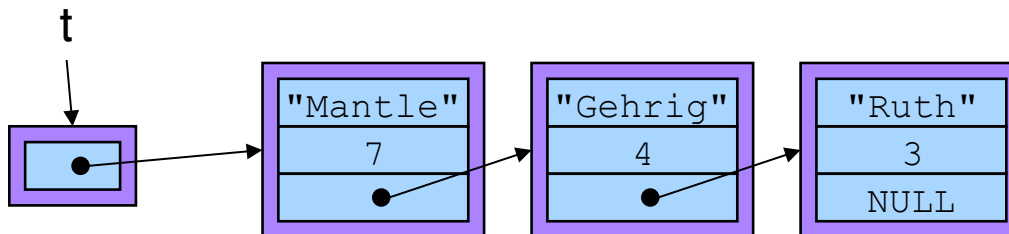



Linked List: Free (2)

```
void Table_free(struct Table *t) {  
    struct Node *p;  
    struct Node *nextp;  
    for (p = t->first; p != NULL; p = nextp) {  
        nextp = p->next;  
        free(p);  
    }  
    free(t);  
}
```

```
struct Table *t;  
...  
Table_free(t);  
...
```

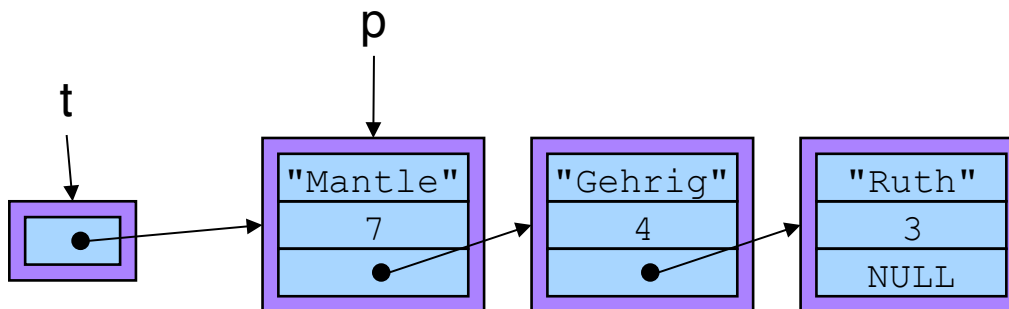



Linked List: Free (3)

```
void Table_free(struct Table *t) {  
    struct Node *p;  
    struct Node *nextp;  
    for (p = t->first; p != NULL; p = nextp) {  
        nextp = p->next;  
        free(p);  
    }  
    free(t);  
}
```

```
struct Table *t;  
...  
Table_free(t);  
...
```

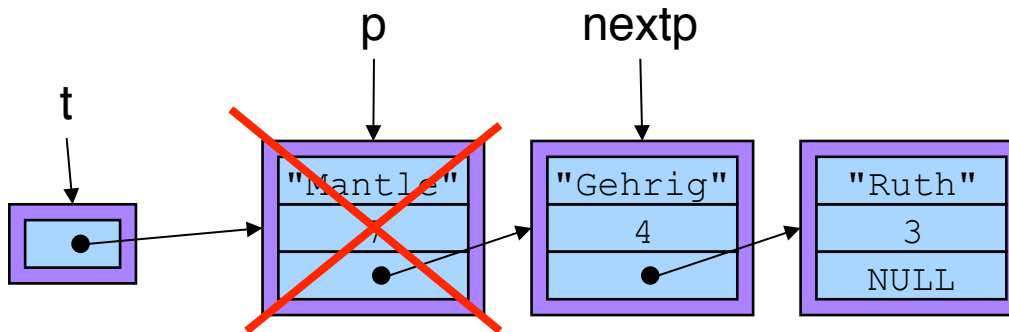



Linked List: Free (4)

```
void Table_free(struct Table *t) {  
    struct Node *p;  
    struct Node *nextp;  
    for (p = t->first; p != NULL; p = nextp) {  
        nextp = p->next;  
        free(p);  
    }  
    free(t);  
}
```

```
struct Table *t;  
...  
Table_free(t);  
...
```

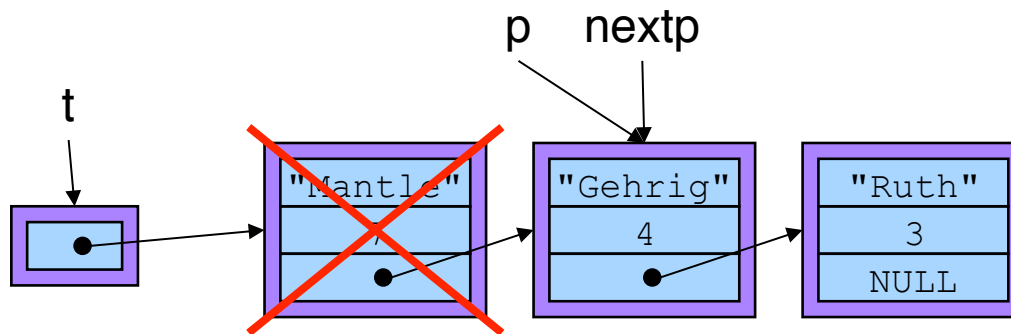



Linked List: Free (5)

```
void Table_free(struct Table *t) {  
    struct Node *p;  
    struct Node *nextp;  
    for (p = t->first; p != NULL; p = nextp) {  
        nextp = p->next;  
        free(p);  
    }  
    free(t);  
}
```

```
struct Table *t;  
...  
Table_free(t);  
...
```

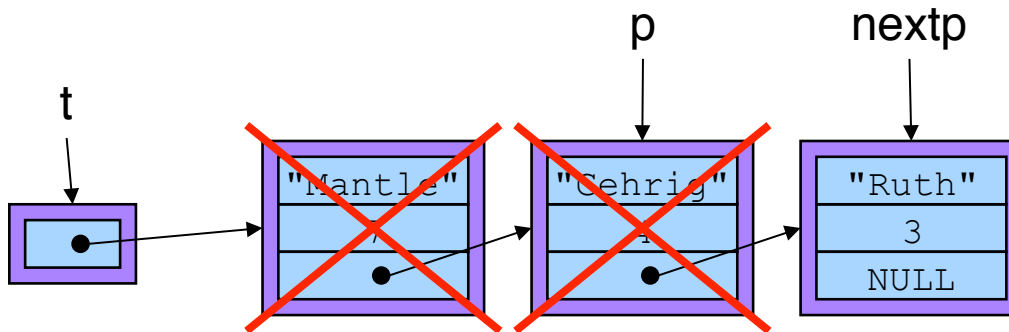



Linked List: Free (6)

```
void Table_free(struct Table *t) {  
    struct Node *p;  
    struct Node *nextp;  
    for (p = t->first; p != NULL; p = nextp) {  
        nextp = p->next;  
        free(p);  
    }  
    free(t);  
}
```

```
struct Table *t;  
...  
Table_free(t);  
...
```

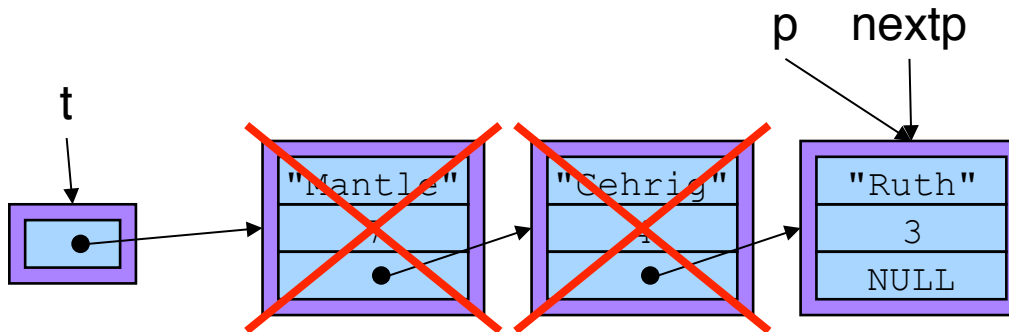



Linked List: Free (7)

```
void Table_free(struct Table *t) {  
    struct Node *p;  
    struct Node *nextp;  
    for (p = t->first; p != NULL; p = nextp) {  
        nextp = p->next;  
        free(p);  
    }  
    free(t);  
}
```

```
struct Table *t;  
...  
Table_free(t);  
...
```

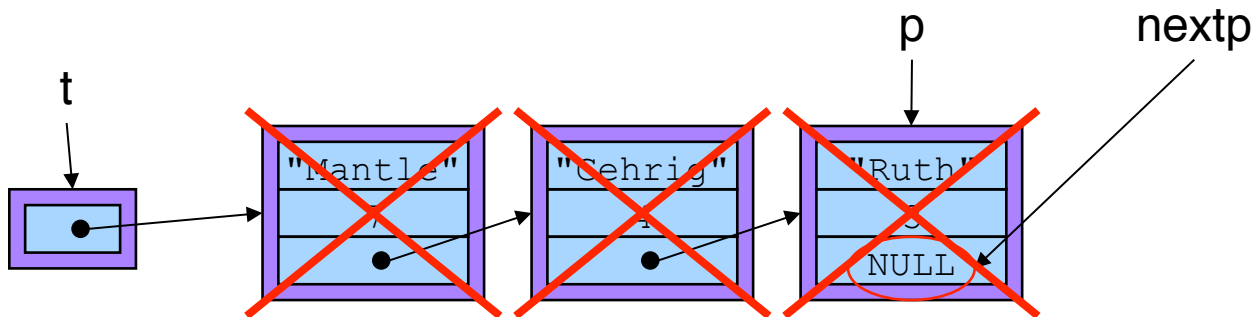



Linked List: Free (8)

```
void Table_free(struct Table *t) {  
    struct Node *p;  
    struct Node *nextp;  
    for (p = t->first; p != NULL; p = nextp) {  
        nextp = p->next;  
        free(p);  
    }  
    free(t);  
}
```

```
struct Table *t;  
...  
Table_free(t);  
...
```

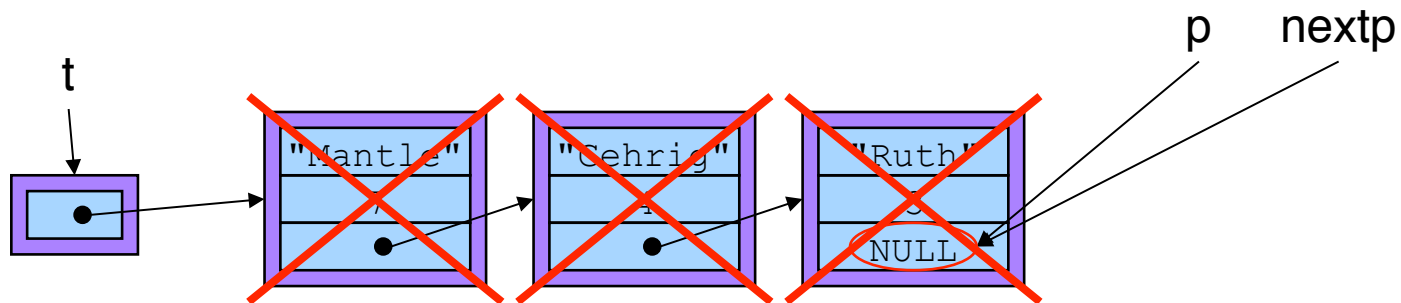



Linked List: Free (9)

```
void Table_free(struct Table *t) {  
    struct Node *p;  
    struct Node *nextp;  
    for (p = t->first; p != NULL; p = nextp) {  
        nextp = p->next;  
        free(p);  
    }  
    free(t);  
}
```

```
struct Table *t;  
...  
Table_free(t);  
...
```

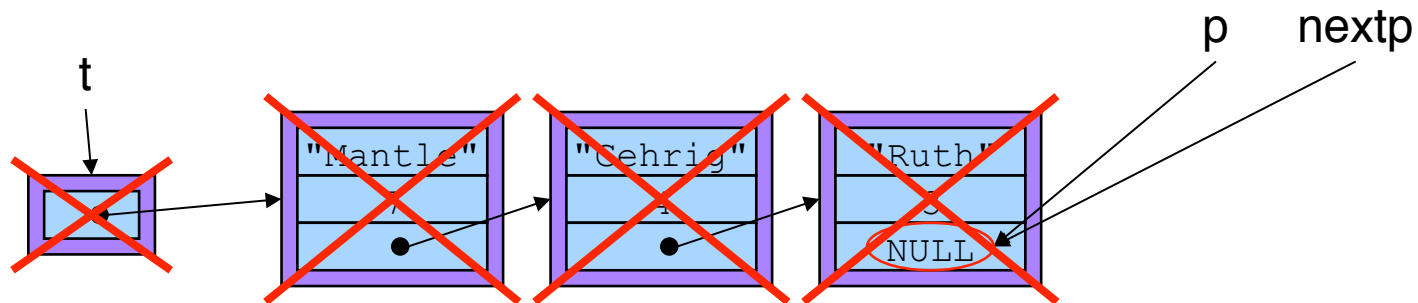



Linked List Performance

- Create: fast
- Add: fast
- Search: slow
- Free: slow

What are the asymptotic run times (big-oh notation)?

Would it be better to keep the nodes sorted by key?



Data Structure #2: Hash Table

- Fixed-size array where each element points to a linked list

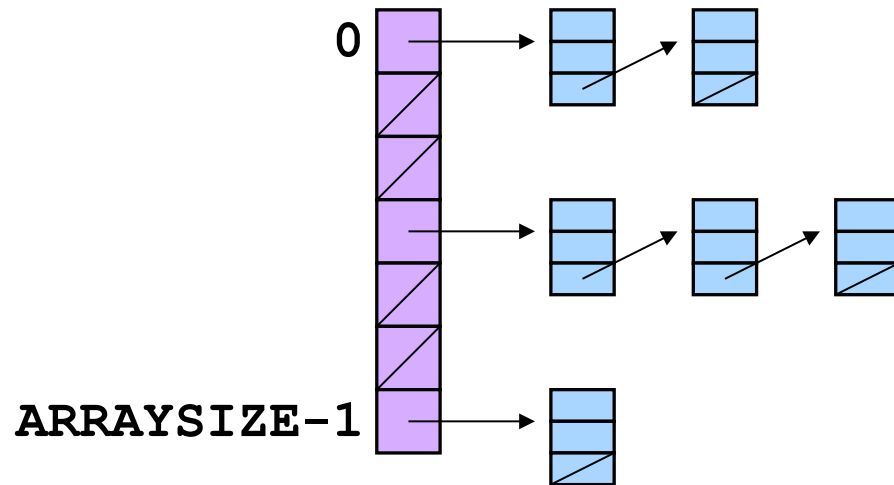

```
struct Node *array[ARRAYSIZE];
```

- Function maps each key to an array index
 - For example, for an integer key h
 - Hash function: $i = h \% \text{ARRAYSIZE}$ (mod function)
 - Go to array element i , i.e., the linked list `hashtab[i]`
 - Search for element, add element, remove element, etc.



Hash Table Example

- Integer keys, array of size 5 with hash function “ $h \text{ mod } 5$ ”
 - “ $1776 \% 5$ ” is 1
 - “ $1861 \% 5$ ” is 1
 - “ $1939 \% 5$ ” is 4

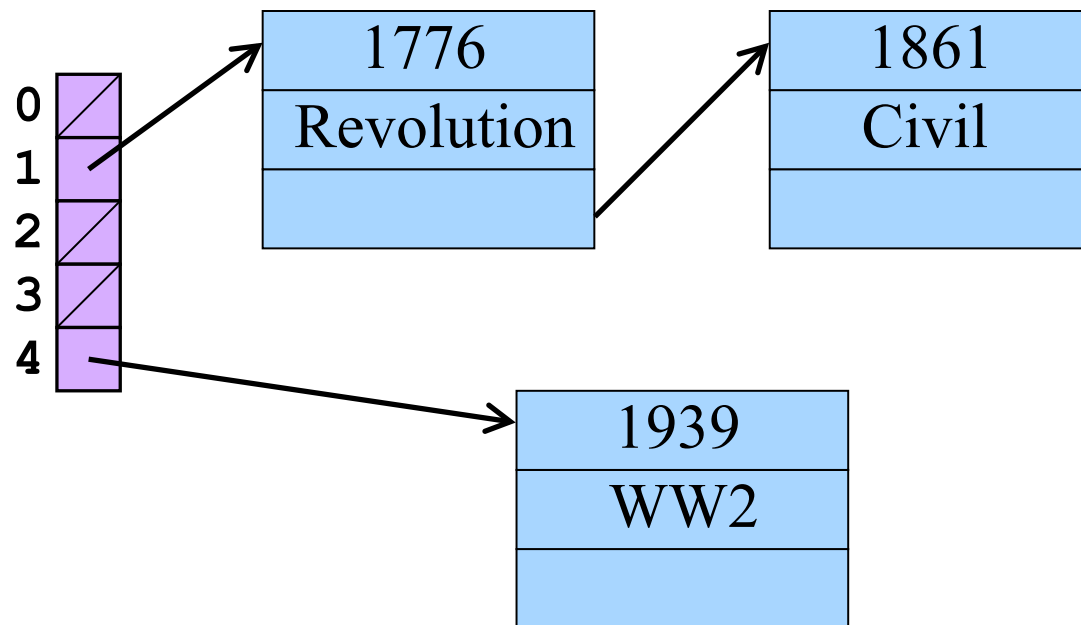



What Kind of Hash Function?

- Good at distributing elements across the array
 - Distribute results over the range $0, 1, \dots, \text{ARRAYSIZE}-1$
 - Distribute results *evenly* to avoid very long buckets
- This is not so good:

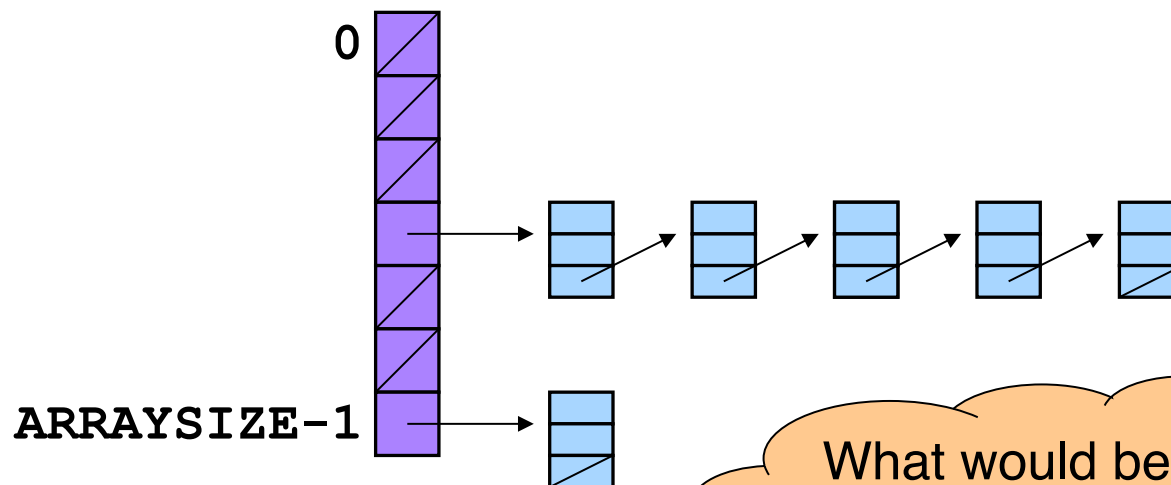

What would be the worst possible hash function?



Hashing String Keys to Integers

- Simple schemes don't distribute the keys evenly enough
 - Number of characters, mod ARRAYSIZE
 - Sum the ASCII values of all characters, mod ARRAYSIZE
 - ...
- Here's a reasonably good hash function
 - Weighted sum of characters x_i in the string
 - $(\sum a^i x_i) \text{ mod ARRAYSIZE}$
 - Best if a and ARRAYSIZE are relatively prime
 - E.g., $a = 65599$, ARRAYSIZE = 1024



Implementing Hash Function

- Potentially expensive to compute a^i for each value of i
 - Computing a^i for each value of i
 - Instead, do $((x[0] * 65599 + x[1]) * 65599 + x[2]) * 65599 + x[3]) * \dots$

```
unsigned int hash(const char *x) {  
    int i;  
    unsigned int h = 0U;  
    for (i=0; x[i]!='\0'; i++)  
        h = h * 65599 + (unsigned char)x[i];  
    return h % 1024;  
}
```

Can be more clever than this for powers of two!
(Described in Appendix)



Hash Table Example

Example: `ARRAYSIZE = 7`

Lookup (and enter, if not present) these strings: the, cat, in, the, hat

Hash table initially empty.

First word: the. $\text{hash}(\text{"the"}) = 965156977$. $965156977 \% 7 = 1$.

Search the linked list `table[1]` for the string "the"; not found.

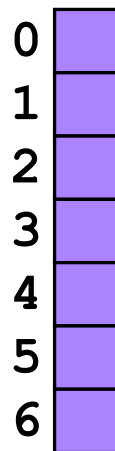



Hash Table Example (cont.)

Example: `ARRAYSIZE = 7`

Lookup (and enter, if not present) these strings: the, cat, in, the, hat

Hash table initially empty.

First word: "the". $\text{hash}(\text{"the"}) = 965156977$. $965156977 \% 7 = 1$.

Search the linked list `table[1]` for the string "the"; not found

Now: `table[1] = makelink(key, value, table[1])`

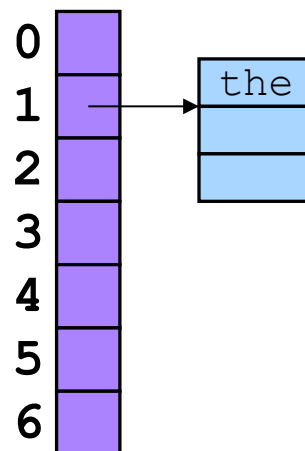



Hash Table Example (cont.)

Second word: "cat". $\text{hash}(\text{"cat"}) = 3895848756$. $3895848756 \% 7 = 2$.

Search the linked list `table[2]` for the string "cat"; not found

Now: `table[2] = makelink(key, value, table[2])`

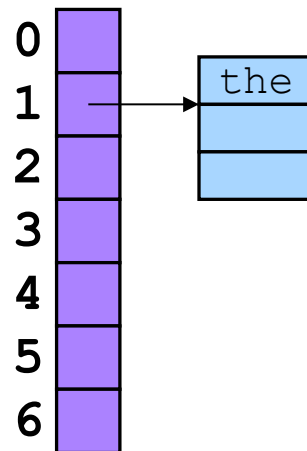



Hash Table Example (cont.)

Third word: "in". $\text{hash}(\text{"in"}) = 6888005$. $6888005 \% 7 = 5$.

Search the linked list `table[5]` for the string "in"; not found

Now: `table[5] = makelink(key, value, table[5])`

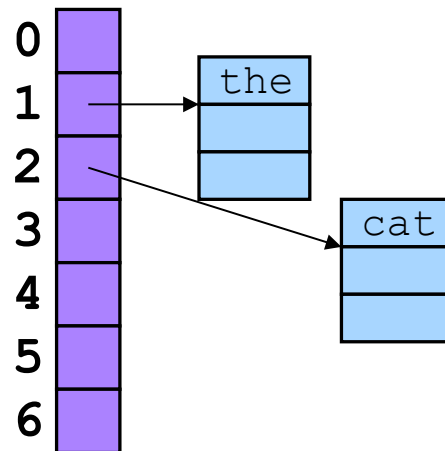



Hash Table Example (cont.)

Fourth word: "the". $\text{hash}(\text{"the"}) = 965156977$. $965156977 \% 7 = 1$.

Search the linked list `table[1]` for the string "the"; found it!

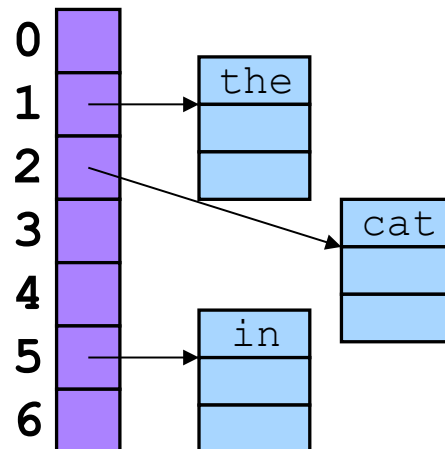



Hash Table Example (cont.)

Fourth word: "hat". $\text{hash}(\text{"hat"}) = 865559739$. $865559739 \% 7 = 2$.

Search the linked list `table[2]` for the string "hat"; not found.

Now, insert "hat" into the linked list `table[2]`.

At beginning or end? Doesn't matter.

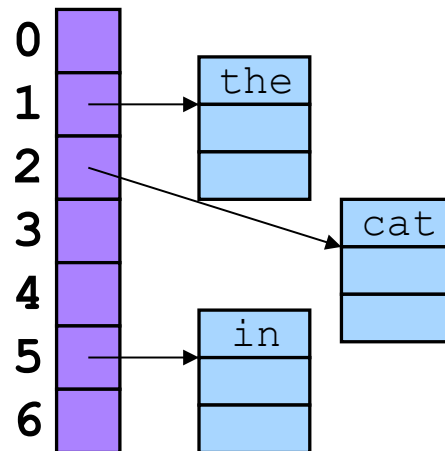



Hash Table Example (cont.)

Inserting at the front is easier, so add "hat" at the front

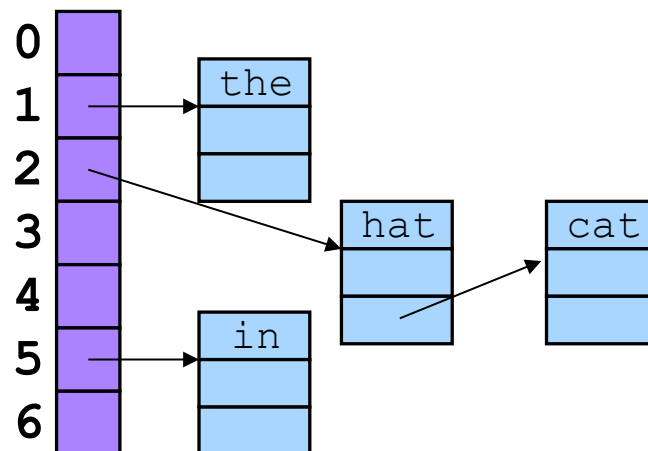



Hash Table: Data Structure

```
enum {BUCKET_COUNT = 1024};

struct Node {
    const char *key;
    int value;
    struct Node *next;
};

struct Table {
    struct Node *array[BUCKET_COUNT];
};
```

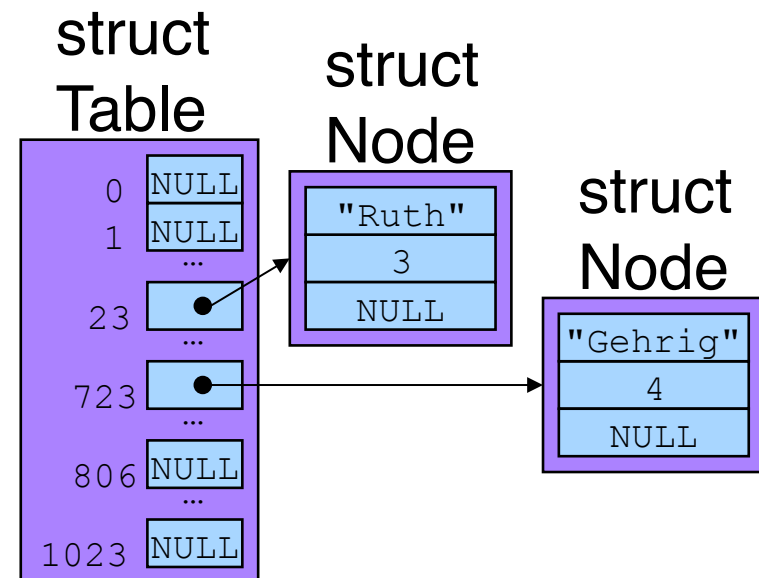



Hash Table: Create

```
struct Table *Table_create(void) {  
    struct Table *t;  
    t = (struct Table*)calloc(1, sizeof(struct Table));  
    return t;  
}
```

```
struct Table *t;  
...  
t = Table_create();  
...
```

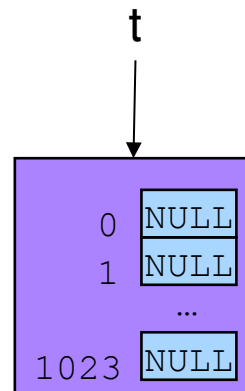



Hash Table: Add (1)

```
void Table_add(struct Table *t,  
const char *key, int value) {  
    struct Node *p = (struct Node*)malloc(sizeof(struct Node));  
    int h = hash(key);  
    p->key = key;  
    p->value = value;  
    p->next = t->array[h];  
    t->array[h] = p;  
}
```

```
struct Table *t;  
...  
Table_add(t, "Ruth", 3);  
Table_add(t, "Gehrig", 4);  
Table_add(t, "Mantle", 7);  
...
```

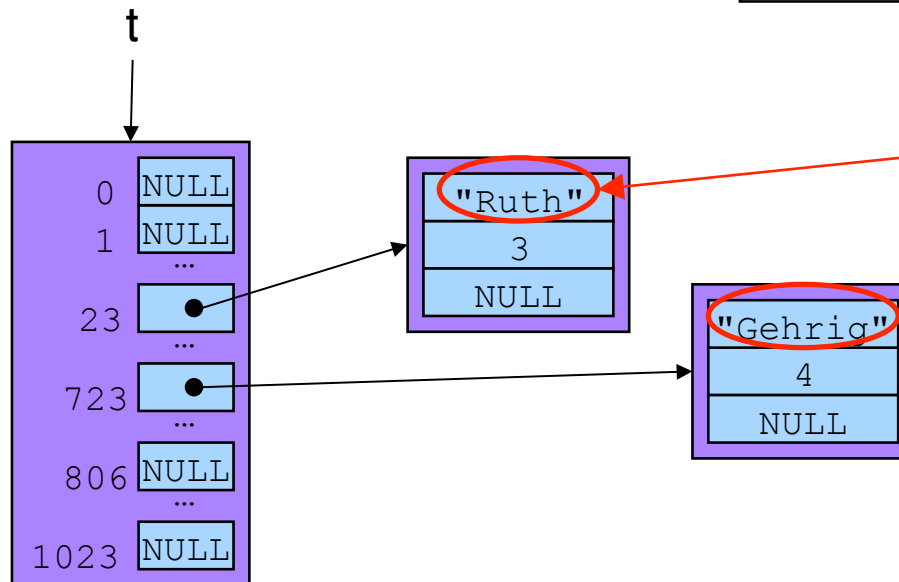

These are pointers to strings

Pretend that "Ruth" hashed to 23 and "Gehrig" to 723



Hash Table: Add (2)

```
void Table_add(struct Table *t,  
const char *key, int value) {  
    struct Node *p = (struct Node*)malloc(sizeof(struct Node));  
    int h = hash(key);  
    p->key = key;  
    p->value = value;  
    p->next = t->array[h];  
    t->array[h] = p;  
}
```

```
struct Table *t;  
...  
Table_add(t, "Ruth", 3);  
Table_add(t, "Gehrig", 4);  
Table_add(t, "Mantle", 7);  
...
```

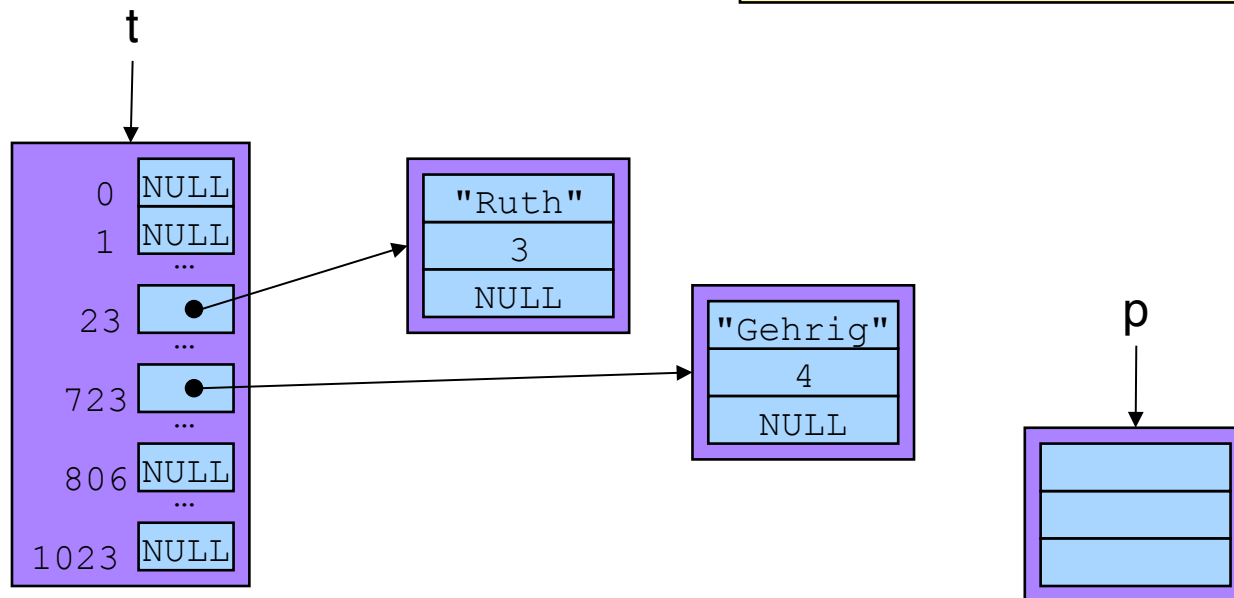



Hash Table: Add (3)

```
void Table_add(struct Table *t,  
const char *key, int value) {  
    struct Node *p = (struct Node*)malloc(sizeof(struct Node));  
    int h = hash(key);  
    p->key = key;  
    p->value = value;  
    p->next = t->array[h];  
    t->array[h] = p;  
}
```

```
struct Table *t;  
...  
Table_add(t, "Ruth", 3);  
Table_add(t, "Gehrig", 4);  
Table_add(t, "Mantle", 7);  
...
```

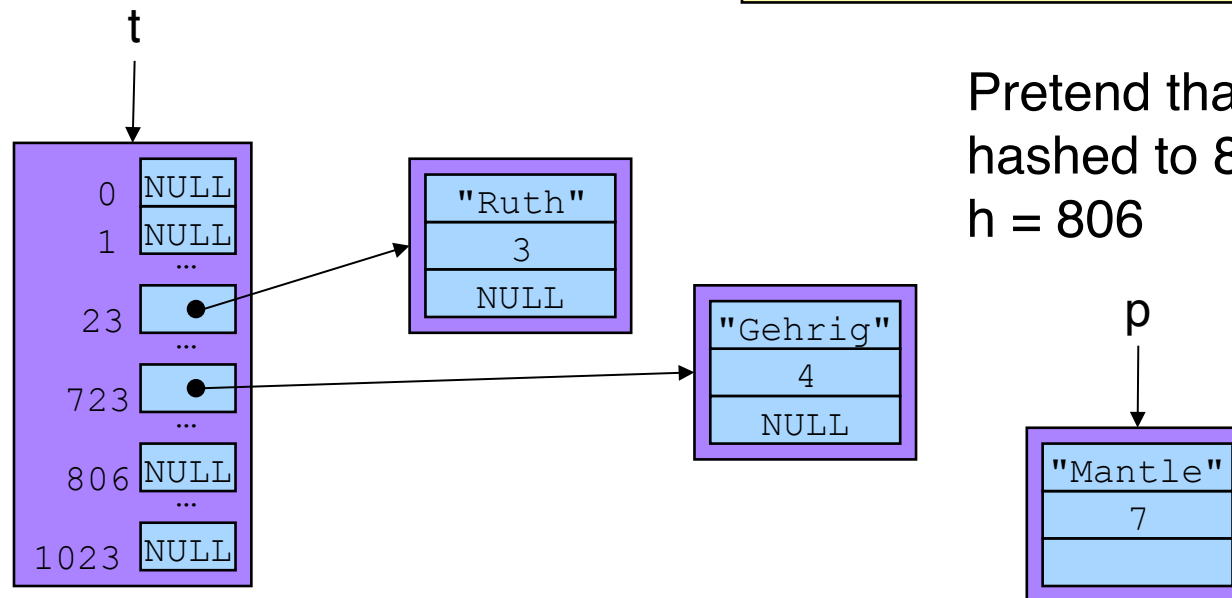

Pretend that "Mantle"
hashed to 806, and so
 $h = 806$



Hash Table: Add (4)

```
void Table_add(struct Table *t,  
const char *key, int value) {  
    struct Node *p = (struct Node*)malloc(sizeof(struct Node));  
    int h = hash(key);  
    p->key = key;  
    p->value = value;  
    p->next = t->array[h];  
    t->array[h] = p;  
}
```

```
struct Table *t;  
...  
Table_add(t, "Ruth", 3);  
Table_add(t, "Gehrig", 4);  
Table_add(t, "Mantle", 7);  
...
```

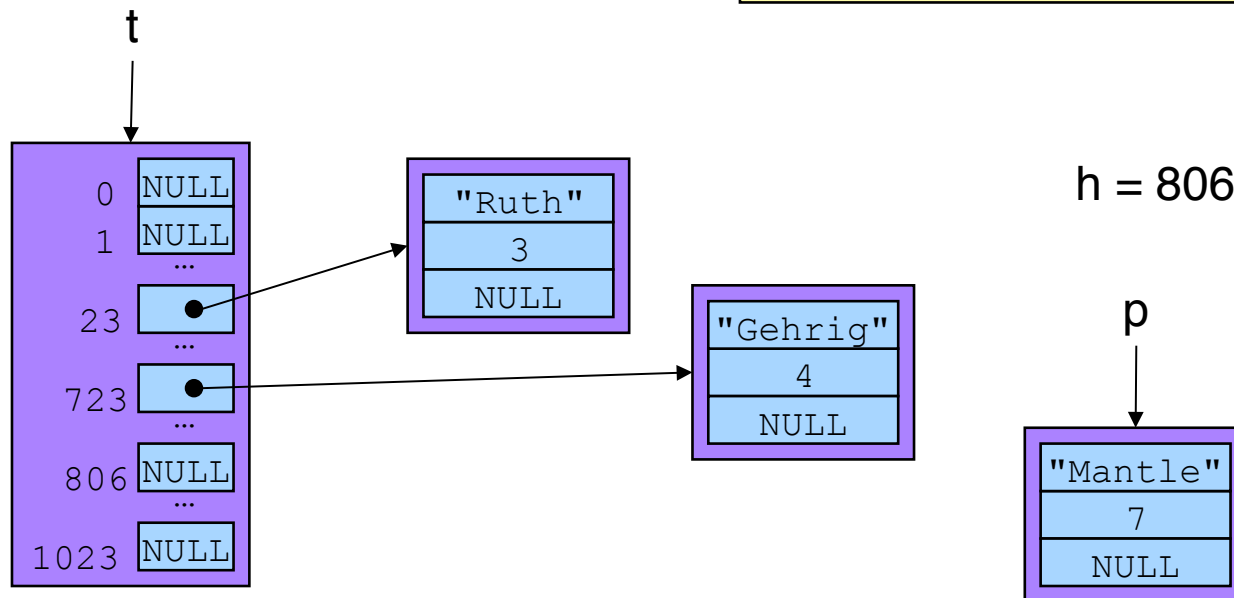



Hash Table: Add (5)

```
void Table_add(struct Table *t,  
const char *key, int value) {  
    struct Node *p = (struct Node*)malloc(sizeof(struct Node));  
    int h = hash(key);  
    p->key = key;  
    p->value = value;  
    p->next = t->array[h];  
    t->array[h] = p;  
}
```

```
struct Table *t;  
...  
Table_add(t, "Ruth", 3);  
Table_add(t, "Gehrig", 4);  
Table_add(t, "Mantle", 7);  
...
```

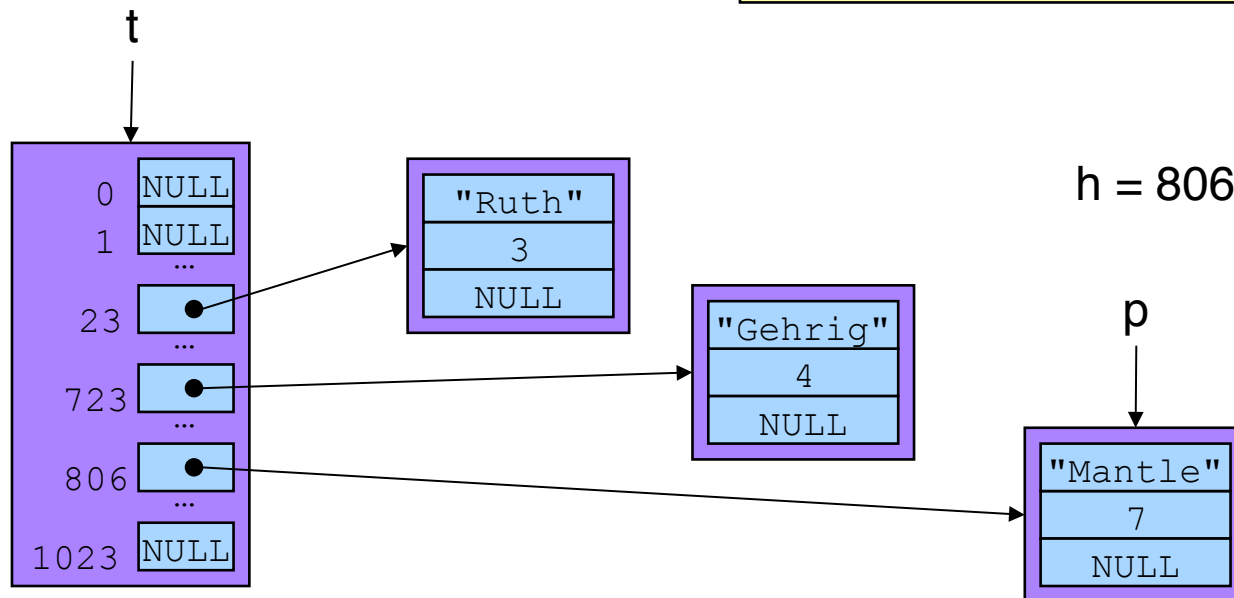



Hash Table: Search (1)

```
int Table_search(struct Table *t,  
const char *key, int *value) {  
    struct Node *p;  
    int h = hash(key);  
    for (p = t->array[h]; p != NULL; p = p->next)  
        if (strcmp(p->key, key) == 0) {  
            *value = p->value;  
            return 1;  
        }  
    return 0;  
}
```

```
struct Table *t;  
int value;  
int found;  
...  
found =  
    Table_search(t, "Gehrig", &value);  
...
```

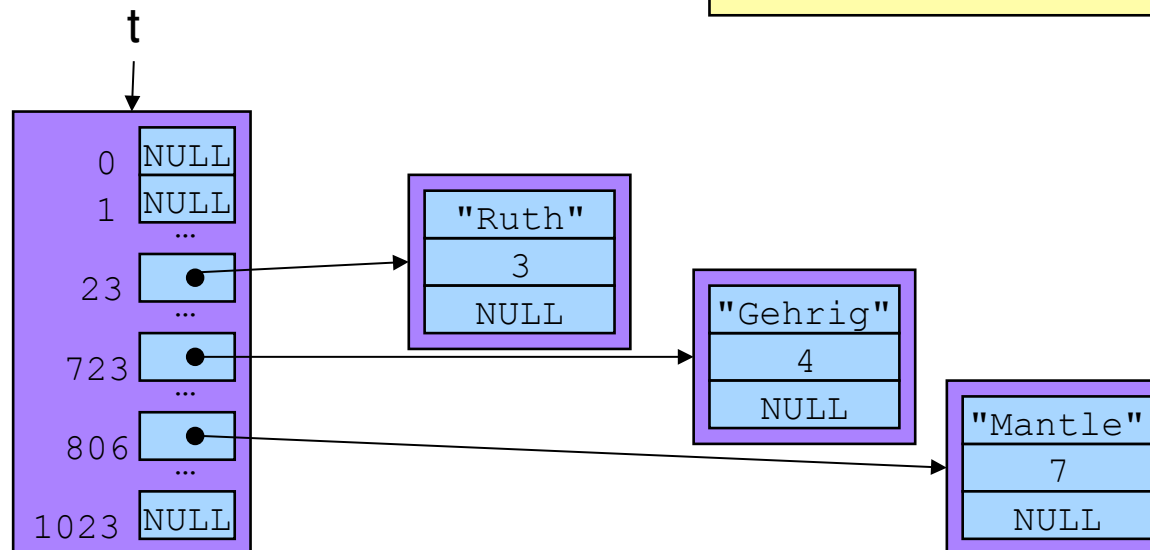



Hash Table: Search (2)

```
int Table_search(struct Table *t,  
const char *key, int *value) {  
    struct Node *p;  
    int h = hash(key);  
    for (p = t->array[h]; p != NULL; p = p->next)  
        if (strcmp(p->key, key) == 0) {  
            *value = p->value;  
            return 1;  
        }  
    return 0;  
}
```

```
struct Table *t;  
int value;  
int found;  
...  
found =  
    Table_search(t, "Gehrig", &value);  
...
```

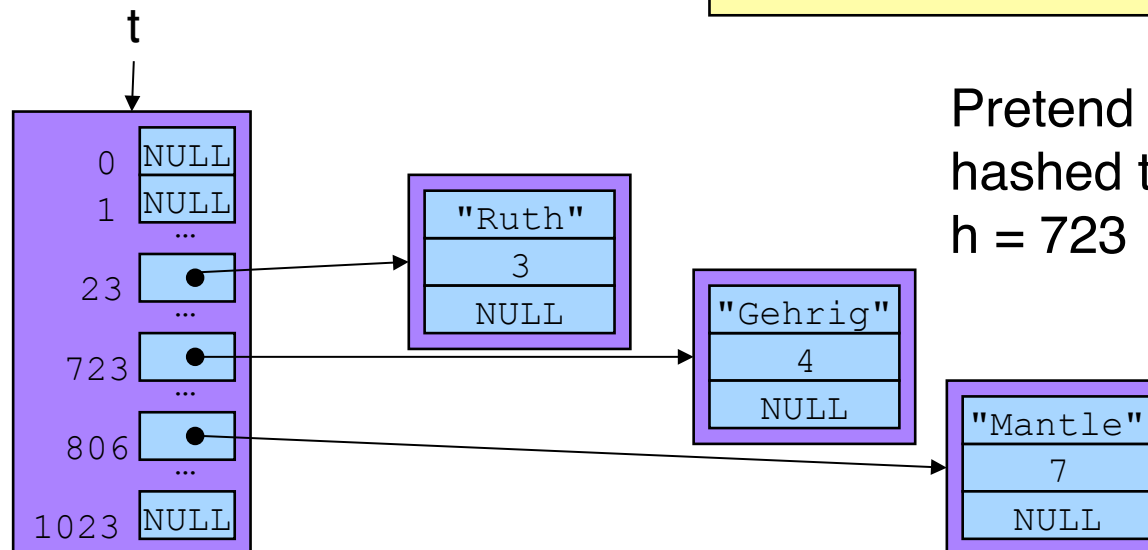



Hash Table: Search (3)

```
int Table_search(struct Table *t,  
const char *key, int *value) {  
    struct Node *p;  
    int h = hash(key);  
    for (p = t->array[h]; p != NULL; p = p->next)  
        if (strcmp(p->key, key) == 0) {  
            *value = p->value;  
            return 1;  
        }  
    return 0;  
}
```

```
struct Table *t;  
int value;  
int found;  
...  
found =  
    Table_search(t, "Gehrig", &value);  
...
```

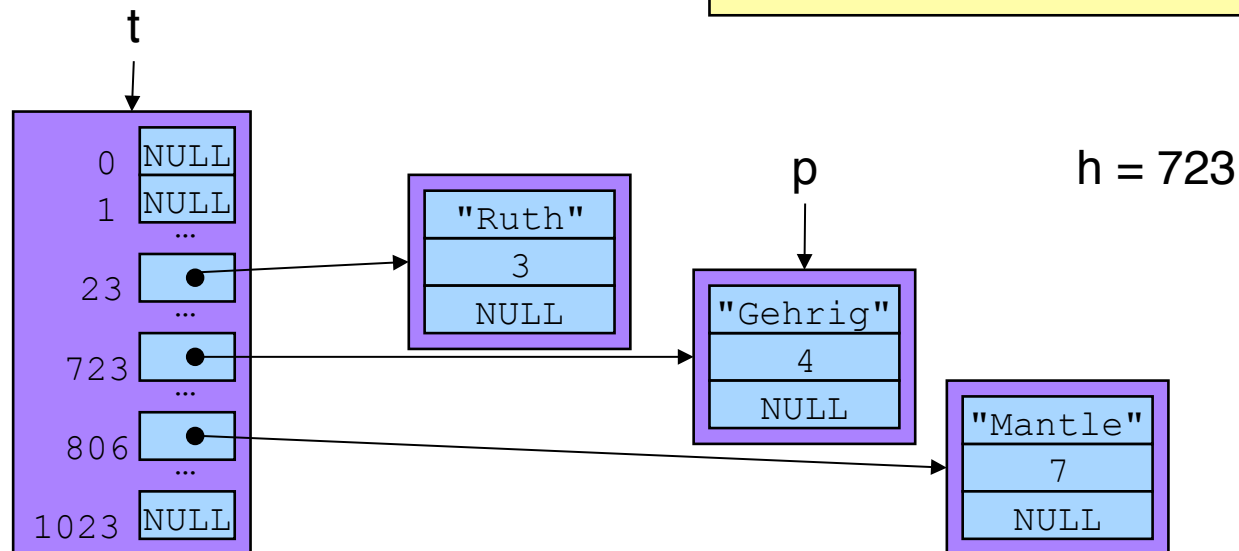



Hash Table: Search (4)

```
int Table_search(struct Table *t,  
const char *key, int *value) {  
    struct Node *p;  
    int h = hash(key);  
    for (p = t->array[h]; p != NULL; p = p->next)  
        if (strcmp(p->key, key) == 0) {  
            *value = p->value;  
            return 1;  
        }  
    return 0;  
}
```

```
struct Table *t;  
int value;  
int found;  
...  
found =  
    Table_search(t, "Gehrig", &value);  
...
```

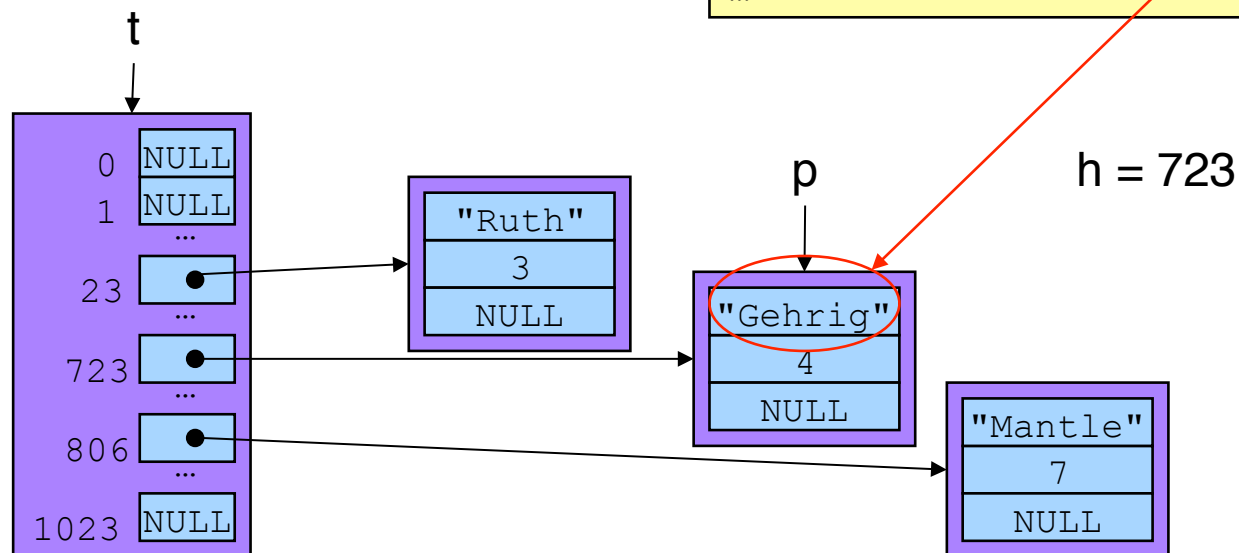



Hash Table: Free (1)

```
void Table_free(struct Table *t) {  
    struct Node *p;  
    struct Node *nextp;  
    int b;  
    for (b = 0; b < BUCKET_COUNT; b++)  
        for (p = t->array[b]; p != NULL; p = nextp) {  
            nextp = p->next;  
            free(p);  
        }  
    free(t);  
}
```

```
struct Table *t;  
...  
Table_free(t);  
...
```

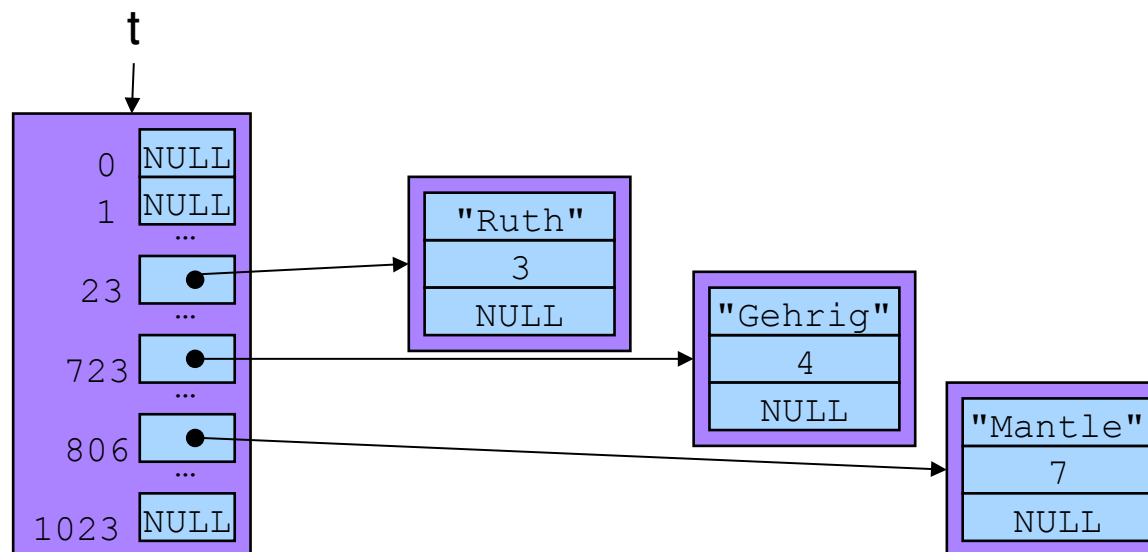



Hash Table: Free (2)

```
void Table_free(struct Table *t) {  
    struct Node *p;  
    struct Node *nextp;  
    int b;  
    for (b = 0; b < BUCKET_COUNT; b++)  
        for (p = t->array[b]; p != NULL; p = nextp) {  
            nextp = p->next;  
            free(p);  
        }  
    free(t);  
}
```

```
struct Table *t;  
...  
Table_free(t);  
...
```

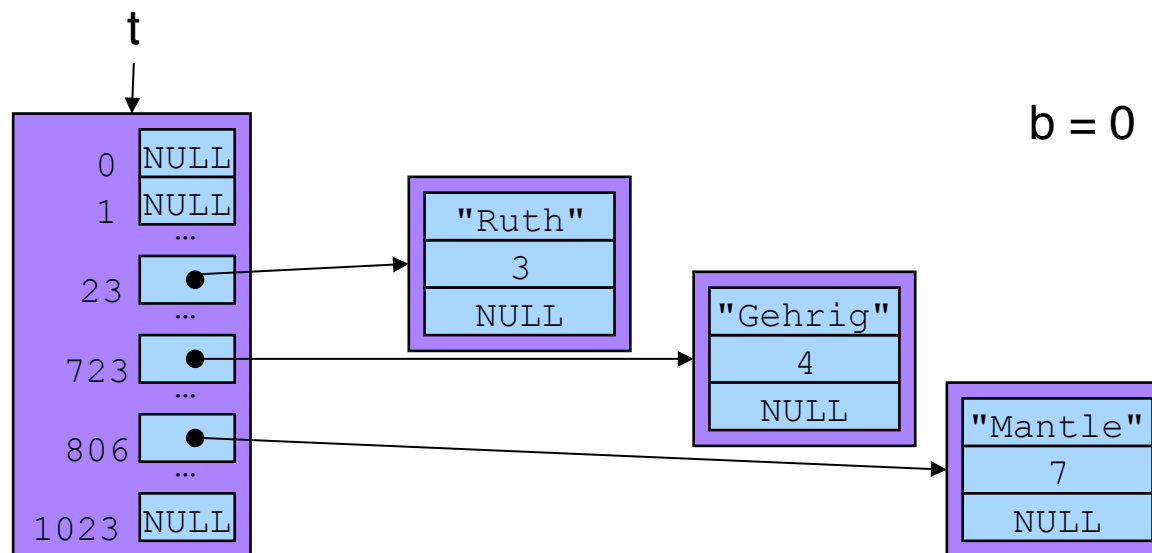



Hash Table: Free (3)

```
void Table_free(struct Table *t) {  
    struct Node *p;  
    struct Node *nextp;  
    int b;  
    for (b = 0; b < BUCKET_COUNT; b++)  
        for (p = t->array[b]; p != NULL; p = nextp) {  
            nextp = p->next;  
            free(p);  
        }  
    free(t);  
}
```

```
struct Table *t;  
...  
Table_free(t);  
...
```

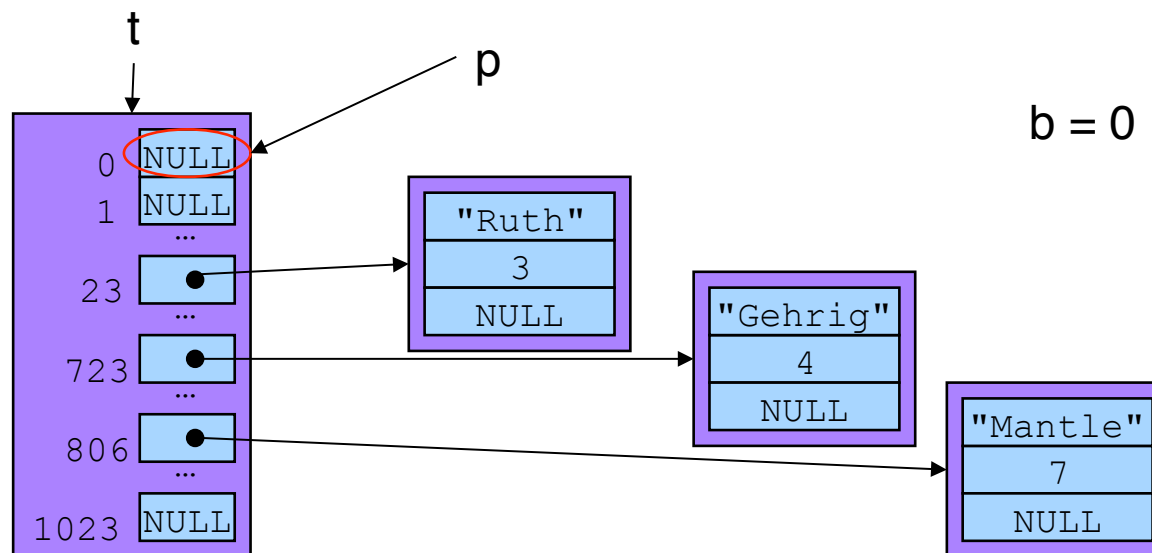



Hash Table: Free (4)

```
void Table_free(struct Table *t) {  
    struct Node *p;  
    struct Node *nextp;  
    int b;  
    for (b = 0; b < BUCKET_COUNT; b++)  
        for (p = t->array[b]; p != NULL; p = nextp) {  
            nextp = p->next;  
            free(p);  
        }  
    free(t);  
}
```

```
struct Table *t;  
...  
Table_free(t);  
...
```

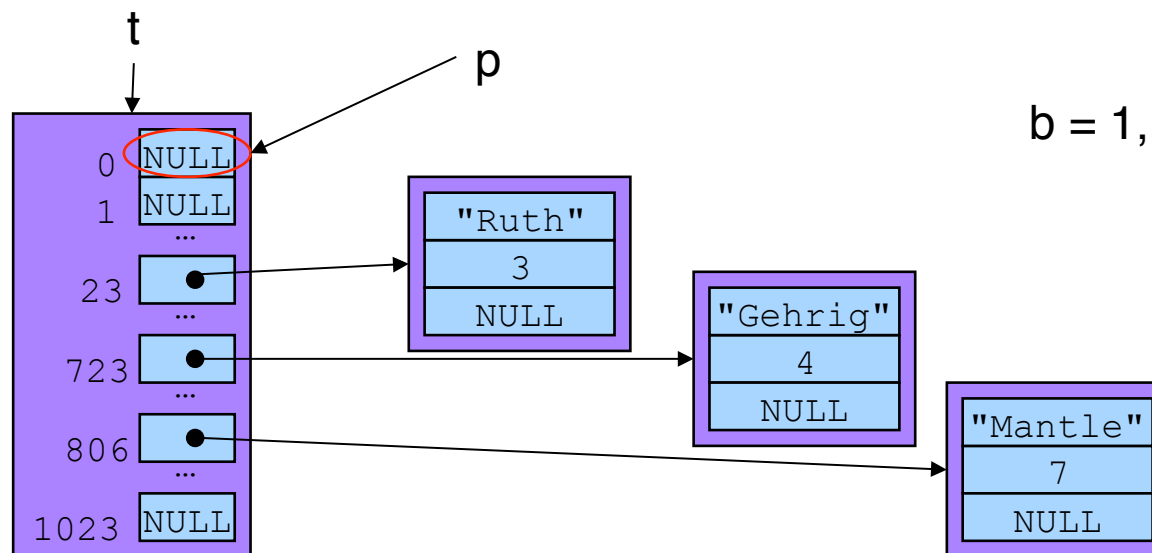



Hash Table: Free (5)

```
void Table_free(struct Table *t) {  
    struct Node *p;  
    struct Node *nextp;  
    int b;  
    for (b = 0; b < BUCKET_COUNT; b++)  
        for (p = t->array[b]; p != NULL; p = nextp) {  
            nextp = p->next;  
            free(p);  
        }  
    free(t);  
}
```

```
struct Table *t;  
...  
Table_free(t);  
...
```

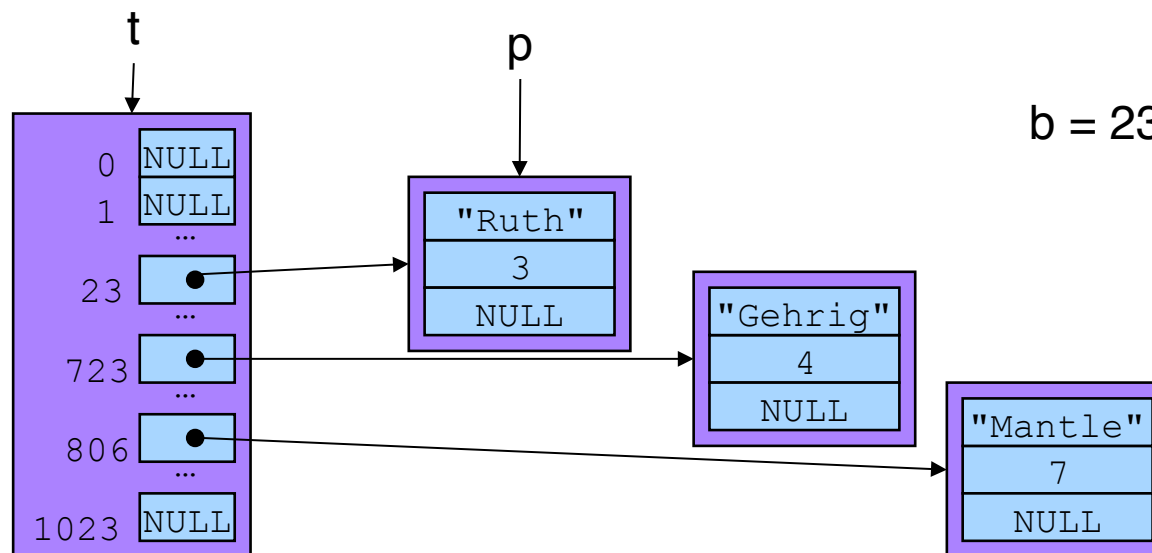



Hash Table: Free (6)

```
void Table_free(struct Table *t) {  
    struct Node *p;  
    struct Node *nextp;  
    int b;  
    for (b = 0; b < BUCKET_COUNT; b++)  
        for (p = t->array[b]; p != NULL; p = nextp) {  
            nextp = p->next;  
            free(p);  
        }  
    free(t);  
}
```

```
struct Table *t;  
...  
Table_free(t);  
...
```

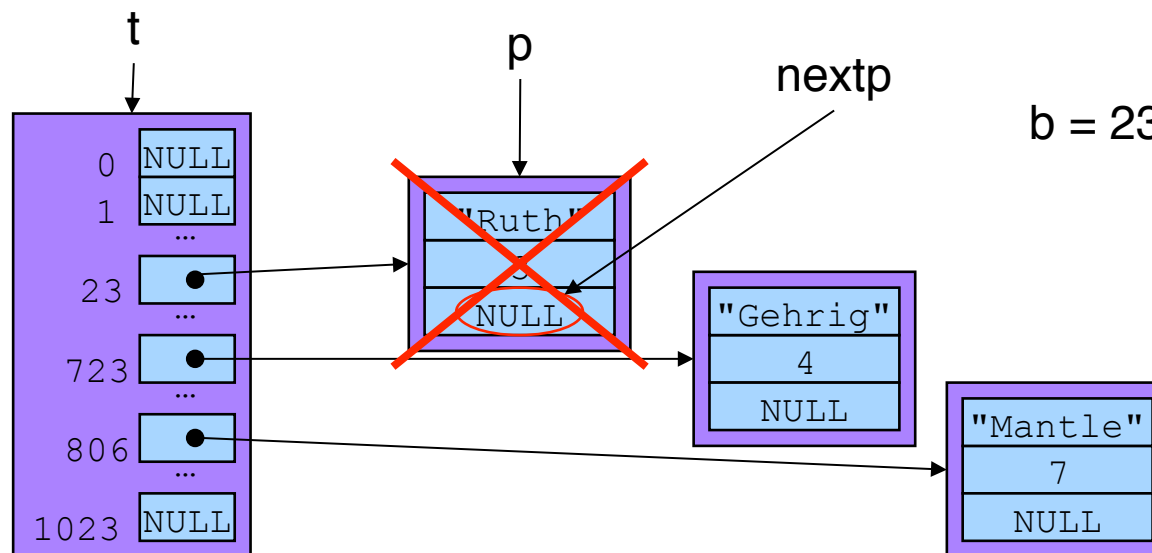



Hash Table: Free (7)

```
void Table_free(struct Table *t) {
    struct Node *p;
    struct Node *nextp;
    int b;
    for (b = 0; b < BUCKET_COUNT; b++)
        for (p = t->array[b]; p != NULL; p = nextp) {
            nextp = p->next;
            free(p);
        }
    free(t);
}
```

```
struct Table *t;
...
Table_free(t);
...
```

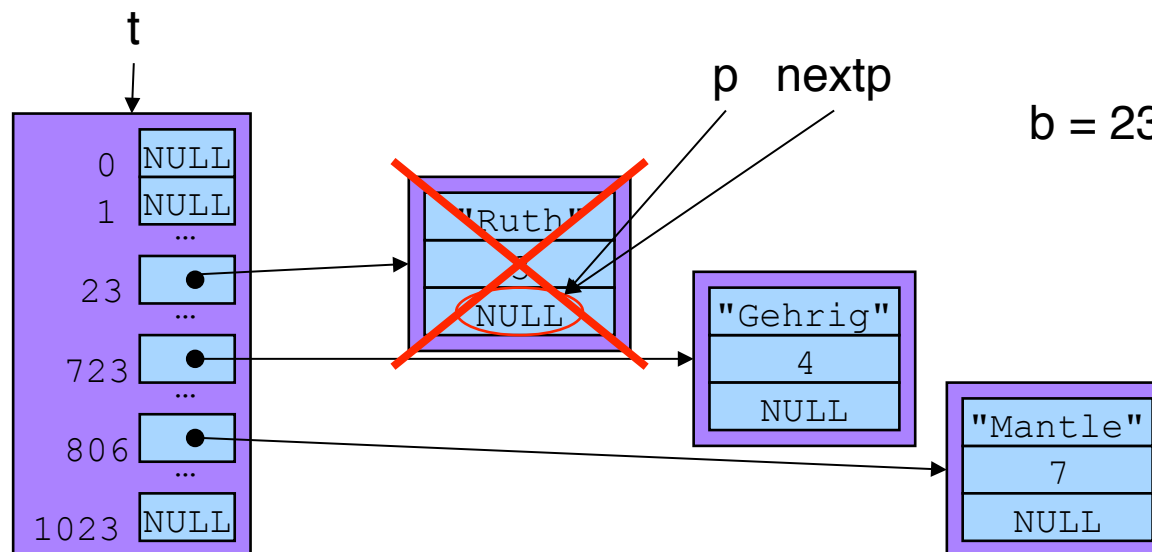



Hash Table: Free (8)

```
void Table_free(struct Table *t) {  
    struct Node *p;  
    struct Node *nextp;  
    int b;  
    for (b = 0; b < BUCKET_COUNT; b++)  
        for (p = t->array[b]; p != NULL; p = nextp) {  
            nextp = p->next;  
            free(p);  
        }  
    free(t);  
}
```

```
struct Table *t;  
...  
Table_free(t);  
...
```

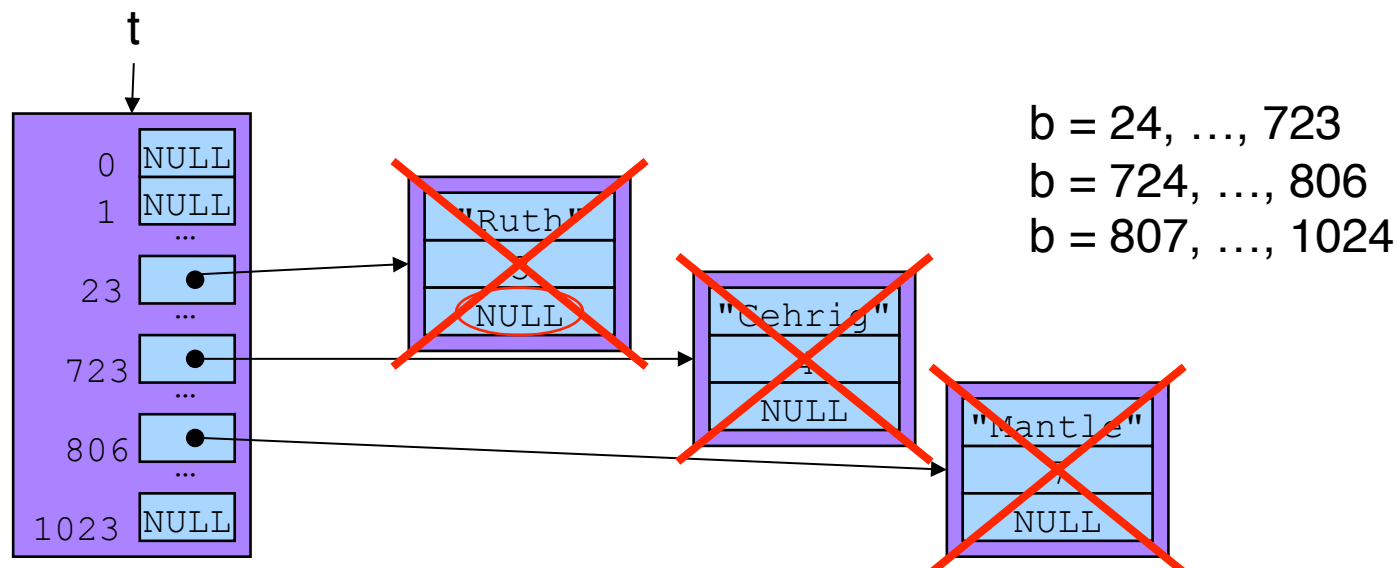



Hash Table: Free (9)

```
void Table_free(struct Table *t) {  
    struct Node *p;  
    struct Node *nextp;  
    int b;  
    for (b = 0; b < BUCKET_COUNT; b++)  
        for (p = t->array[b]; p != NULL; p = nextp) {  
            nextp = p->next;  
            free(p);  
        }  
    free(t);  
}
```

```
struct Table *t;  
...  
Table_free(t);  
...
```

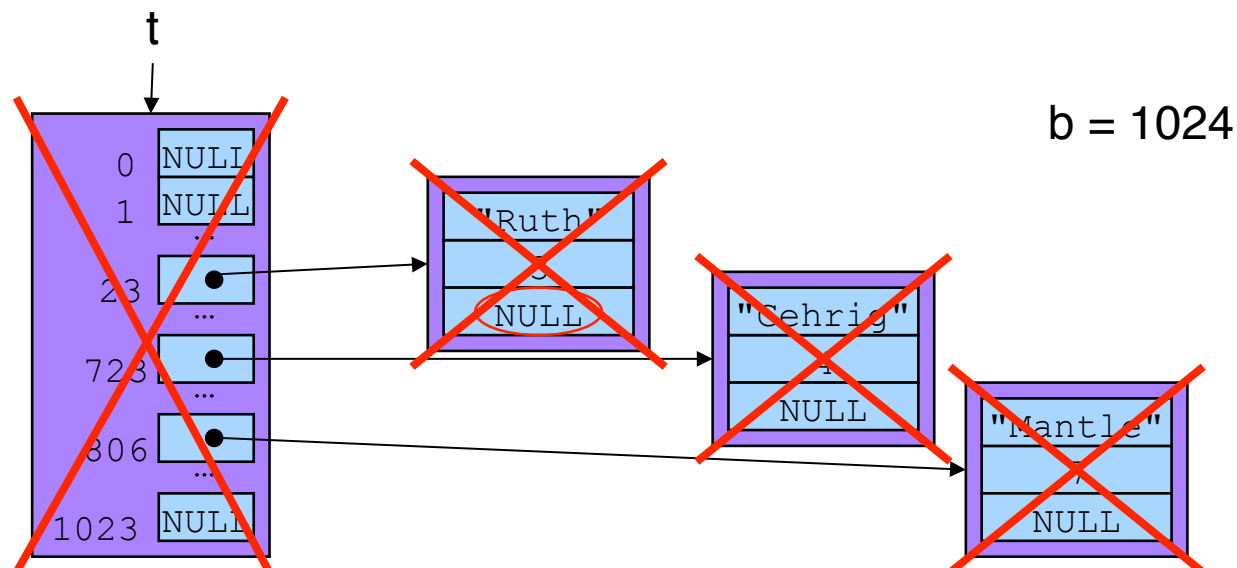



Hash Table Performance

- Create: fast
- Add: fast
- Search: fast
- Free: slow

What are the asymptotic run times (big-oh notation)?

Is hash table search *always* fast?



Key Ownership

- Note: Table_add() functions contain this code:

```
void Table_add(struct Table *t, const char *key, int value) {  
    ...  
    struct Node *p = (struct Node*)malloc(sizeof(struct Node));  
    p->key = key;  
    ...  
}
```

- Caller passes key, which is a pointer to memory where a string resides
- Table_add() function stores within the table the address where the string resides



Key Ownership (cont.)

- Problem: Consider this calling code:

```
struct Table t;  
char k[100] = "Ruth";  
...  
Table_add(t, k, 3);  
strcpy(k, "Gehrig");  
...
```

- Via Table_add(), table contains memory address k
- Client changes string at memory address k
- Thus client changes key within table

What happens if the client searches t for "Ruth"?

What happens if the client searches t for "Gehrig"?



Key Ownership (cont.)

- Solution: Table_add() saves **copy** of given key

```
void Table_add(struct Table *t, const char *key, int value) {  
    ...  
    struct Node *p = (struct Node*)malloc(sizeof(struct Node));  
    p->key = (const char*)malloc(strlen(key) + 1);  
    strcpy(p->key, key);  
    ...  
}
```

Why add 1?

- If client changes string at memory address k, data structure is *not* affected
- Then the data structure “owns” the copy, that is:
 - The data structure is responsible for freeing the memory in which the copy resides
 - The Table_free() function must free the copy



Summary

- Common data structures & associated algorithms
 - **Linked list**
 - Fast insert, slow search
 - **Hash table**
 - Fast insert, (potentially) fast search
 - Invaluable for storing key/value pairs
 - Very common
- **Related issues**
 - Hashing algorithms
 - Memory ownership



Appendix

- “Stupid programmer tricks” related to hash tables...



Revisiting Hash Functions

- Potentially expensive to compute “mod c”
 - Involves division by c and keeping the remainder
 - Easier when c is a power of 2 (e.g., $16 = 2^4$)

- An alternative (by example)

- $53 = 32 + 16 + 4 + 1$

•••	32	16	8	4	2	1	
0	0	1	1	0	1	0	1

- $53 \% 16$ is 5, the last four bits of the number

•••	32	16	8	4	2	1	
0	0	0	0	0	1	0	1

- Would like an easy way to isolate the last four bits...



Recall: Bitwise Operators in C

- Bitwise AND (&)

&	0	1
0	0	0
1	0	1

- Mod on the cheap!
 - E.g., $h = 53 \& 15$;

53

0	0	1	1	0	1	0	1
---	---	---	---	---	---	---	---

& 15

0	0	0	0	1	1	1	1
---	---	---	---	---	---	---	---

5

0	0	0	0	0	1	0	1
---	---	---	---	---	---	---	---

- Bitwise OR (|)

	0	1
0	0	1
1	1	1

- One's complement (~)

- Turns 0 to 1, and 1 to 0
- E.g., set last three bits to 0
 - $x = x \& \sim 7$;



A Faster Hash Function

```
unsigned int hash(const char *x) {  
    int i;  
    unsigned int h = 0U;  
    for (i=0; x[i]!='\0'; i++)  
        h = h * 65599 + (unsigned char)x[i];  
    return h % 1024;  
}
```

Previous
version

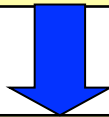

```
unsigned int hash(const char *x) {  
    int i;  
    unsigned int h = 0U;  
    for (i=0; x[i]!='\0'; i++)  
        h = h * 65599 + (unsigned char)x[i];  
    return h & 1023;  
}
```

Faster

What happens if
you mistakenly
write "h & 1024"?



Speeding Up Key Comparisons

- Speeding up key comparisons
 - For any non-trivial value comparison function
 - Trick: store full hash result in structure

```
int Table_search(struct Table *t,  
    const char *key, int *value) {  
    struct Node *p;  
    int h = hash(key); /* No % in hash function */  
    for (p = t->array[h%1024]; p != NULL; p = p->next)  
        if ((p->hash == h) && strcmp(p->key, key) == 0) {  
            *value = p->value;  
            return 1;  
        }  
    return 0;  
}
```

Why is this so much faster?